

Technical Data Sheet

Opto Interrupter SGM8105

■ Features

- Fast response time
- High analytic
- Peak wavelength $\lambda_p=940\text{nm}$
- High sensitivity
- Pb free

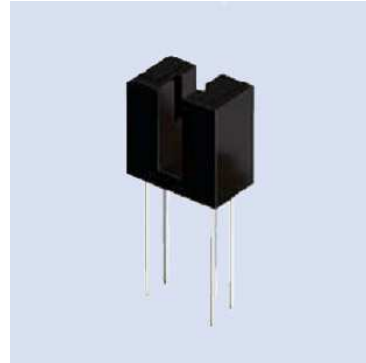

■ Descriptions

The SGM8105 consist of an infrared emitting diode and an NPN silicon phototransistor,encased side-by-side on converging optical axis in a black thermoplastic housing . The phototransistor receives radiation from the IR LED only. This is the normal situation. But when an object is in between , phototransistor could not receives the radiation.

■ Applications

- Non-contact Switching
- Switch Scanner
- For Direct Board
- Floppy disk driver

■ **Package Dimensions**

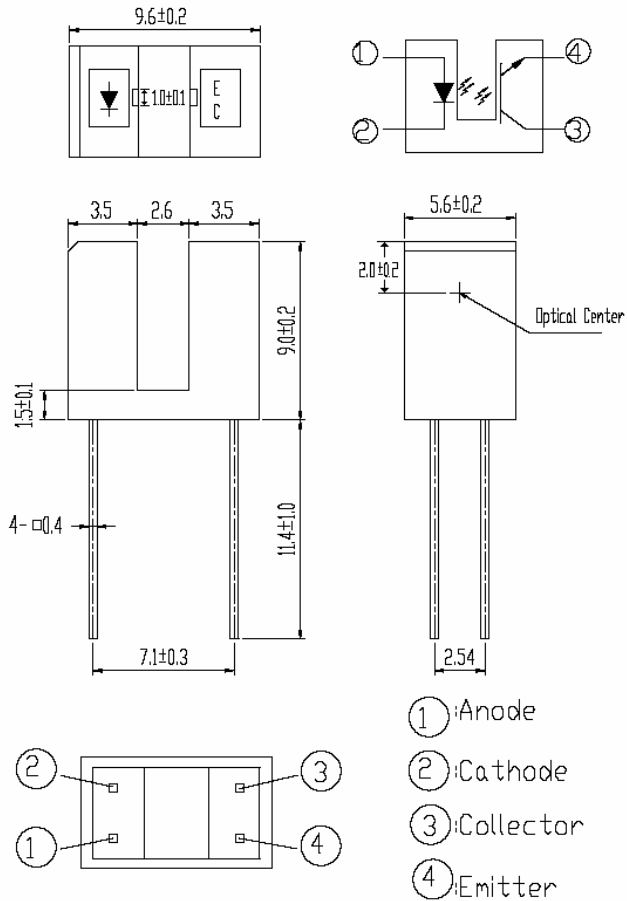

Notes:

1. All dimensions are in millimeters
2. Tolerances unless dimensions $\pm 0.2\text{mm}$
3. Lead spacing is measured where the lead emerge from the package

■ **Absolute Maximum Ratings (Ta=25°C)**

Parameter		Symbol	Ratings	Unit
Input	Power Dissipation at(or below) 25°C Free Air Temperature	Pd	75	mW
	Reverse Voltage	V _R	5	V
	Forward Current	I _F	50	mA
	Peak Forward Current (*1) Pulse width $\leq 100 \mu\text{s}$, Duty cycle=1%	I _{FP}	1	A
	Collector Power Dissipation	Pd	75	mW
Output	Collector Current	I _C	20	mA
	Collector-Emitter Voltage	B V _{CEO}	30	V
	Emitter-Collector Voltage	B V _{ECO}	5	V
	Operating Temperature	Topr	-25~+85	°C
Storage Temperature	Tstg	-40~+85	°C	
Lead Soldering Temperature (*2) (1/16 inch form body for 5 seconds)	Tsol	260	°C	

(*1) $t_w=100 \mu\text{sec.}$, $T=10 \text{msec.}$ (*2) $t=5 \text{Sec}$

Electro-Optical Characteristics (Ta=25°C)

Parameter		Symbol	Min.	Typ.	Max.	Unit	Conditions
Input	Forward Voltage	V_F	---	1.2	1.5	V	$I_F=20\text{mA}$
	Reverse Current	I_R	---	---	10	μA	$V_R=5\text{V}$
	Peak Wavelength	λ_P	---	940	---	nm	$I_F=20\text{mA}$
	View Angle	$2\theta_{1/2}$	---	60	---	Deg	$I_F=20\text{mA}$
Output	Dark C urrent	I_{CEO}	---	---	100	nA	$V_{CE}=20\text{V}, E_e=0\text{mW}/\text{cm}^2$
	C-E Saturation Voltage	$V_{CE}(\text{sat})$	---	---	0.4	V	$I_C=2\text{mA}$ $, E_e=1\text{mW}/\text{cm}^2$
Transfer Characteristics	Collect Current	$I_C(\text{ON})$	0.5	---	10	mA	$V_{CE}=5\text{V}$
		$I_C(\text{OFF})$	---	---	20	μA	$I_F=20\text{mA}$
	Rise time	t_r	---	15	---	μsec	$V_{CE}=5\text{V}$
	Fall time	t_f	---	15	---	μsec	$I_C=1\text{mA}$ $R_L=1\text{K}\Omega$

Typical Electrical/Optical/Characteristics Curves for IR

Fig.1 Forward Current vs. Ambient Temperature

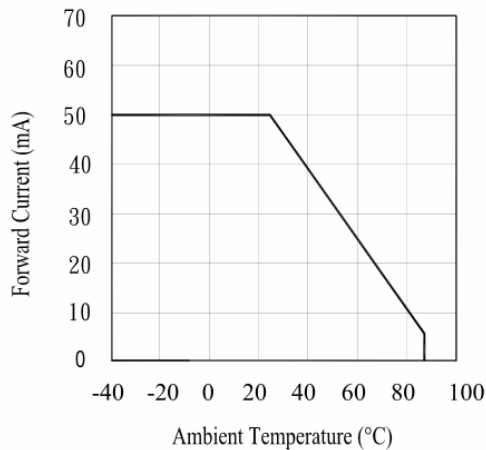

Fig.2 Spectral Distribution

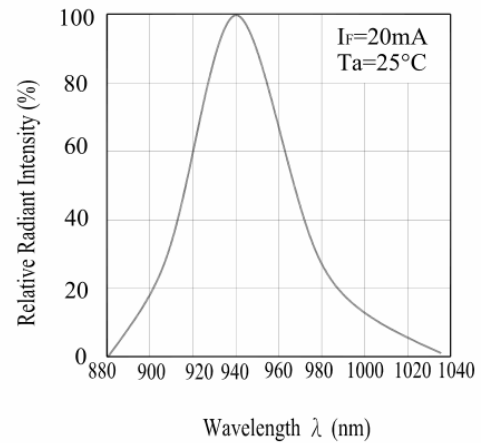

Fig.3 Peak Emission Wavelength vs. Ambient Temperature

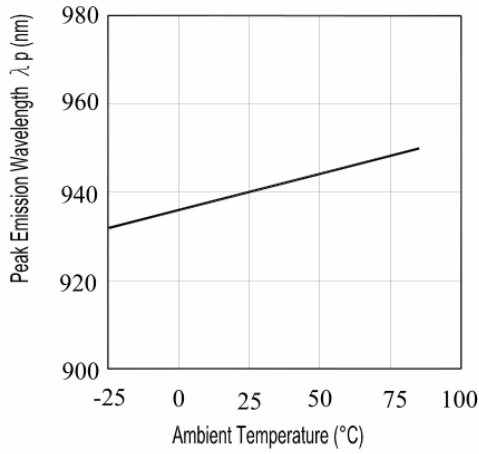

Fig.4 Forward Current vs. Forward Voltage

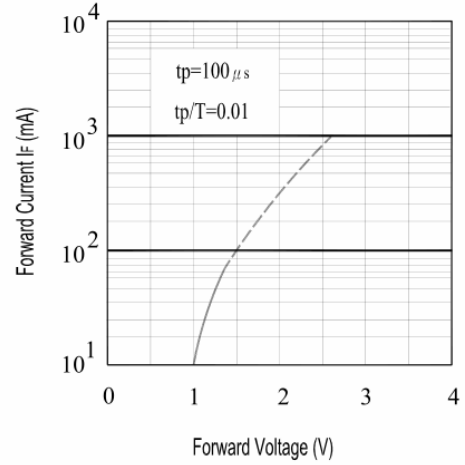

Fig.5 Forward Current vs Ambient Temperature(°C)

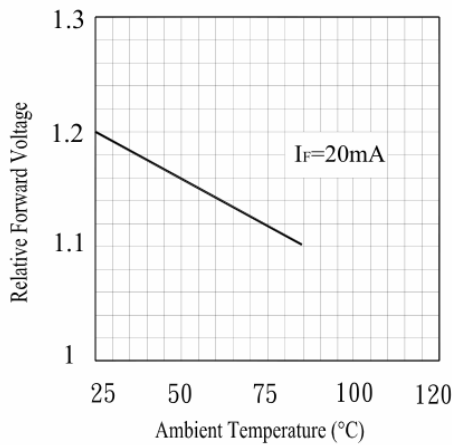
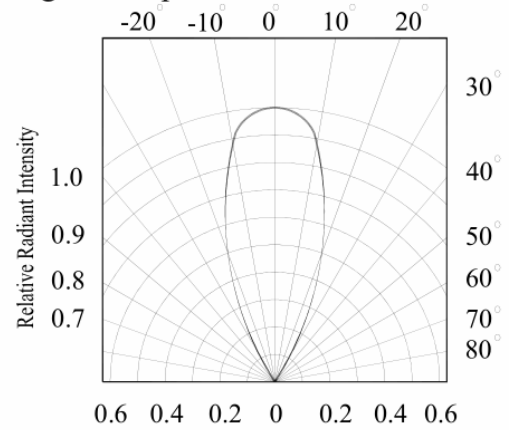

Fig.6 Relative Radiant Intensity vs. Angular Displacement



Typical Electrical/Optical/Characteristics Curves for PT

Fig.1 Collector Power Dissipation vs. Ambient Temperature

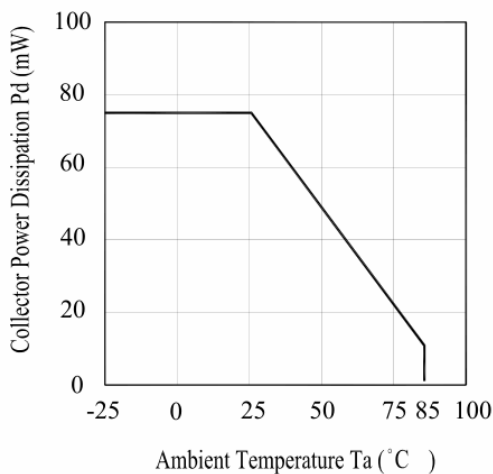

Fig.2 Spectral Sensitivity

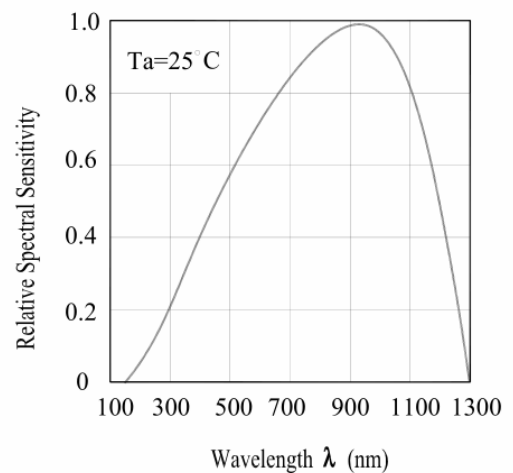

Fig.3 Relative Collector Current vs. Ambient Temperature

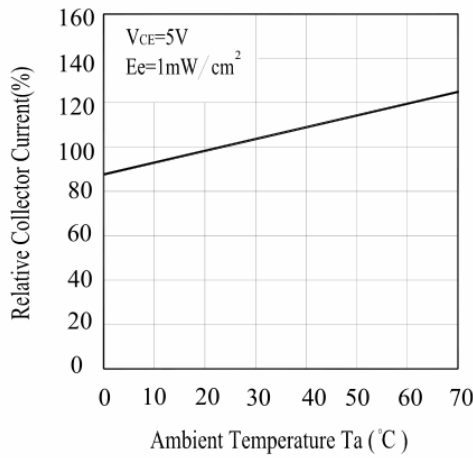

Fig.4 Collector Current vs. Irradiance

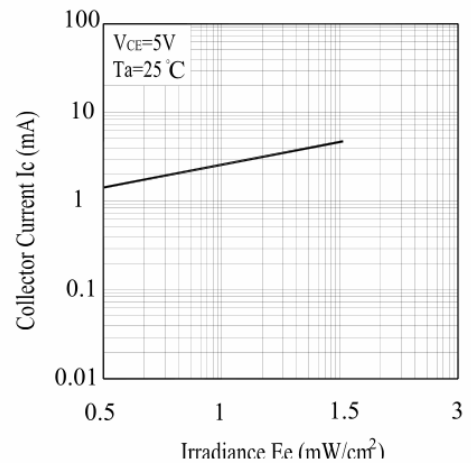

Fig.5 Collector Dark Current vs. Ambient Temperature

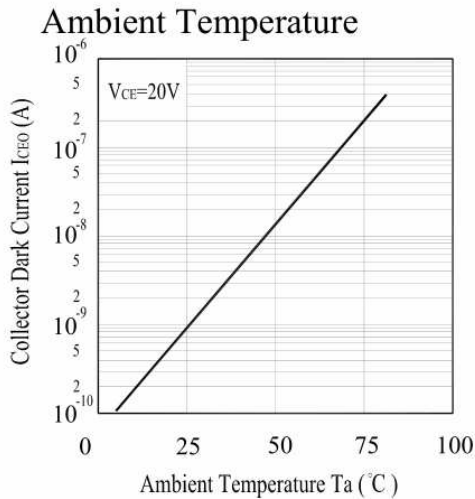
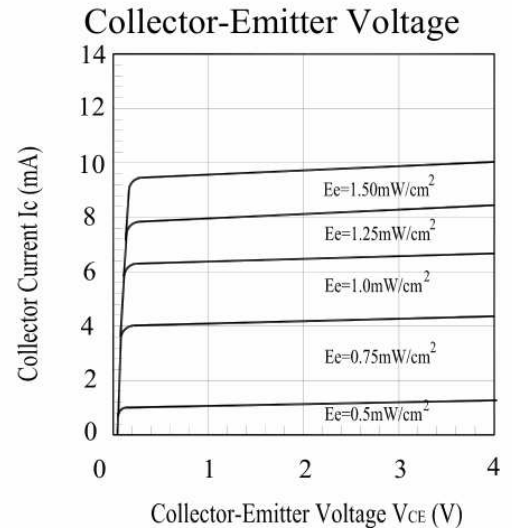

Fig.6 Collector Current vs. Collector-Emitter Voltage



■ **Packing Quantity Specification**

1. 100PCS/1Bag

■ **Notes**

1. Above specification may be changed without notice. SHUGUAN will reserve authority on material change for above specification.
2. When using this product, please observe the absolute maximum ratings and the instructions for using outlined in these specification sheets. SHUGUAN assumes no responsibility for any damage resulting from use of the product which does not comply with the absolute maximum ratings and the instructions included in these specification sheets.
3. These specification sheets include materials protected under copyright of SHUGUAN corporation. Please don't reproduce or cause anyone to reproduce them without SHUGUAN's consent.