

## Technical Data Sheet

### 5mm Semi-Lens Silicon PIN Photodiode: SGPD206C

#### ■ Features

- Fast response time
- High photo sensitivity
- Small junction capacitance
- Pb free
- The product itself will remain within RoHS compliant version.



#### ■ Descriptions

SGPD206C is a high speed and high sensitive PIN photodiode in a flat side view plastic package. Due to its water clear epoxy the device is sensitive to visible and infrared radiation.

#### ■ Applications

- High speed photo detector
- VCRs , Video camera
- Camera
- Optoelectronic switch
- Scanning Gun

#### ■ Package Dimensions

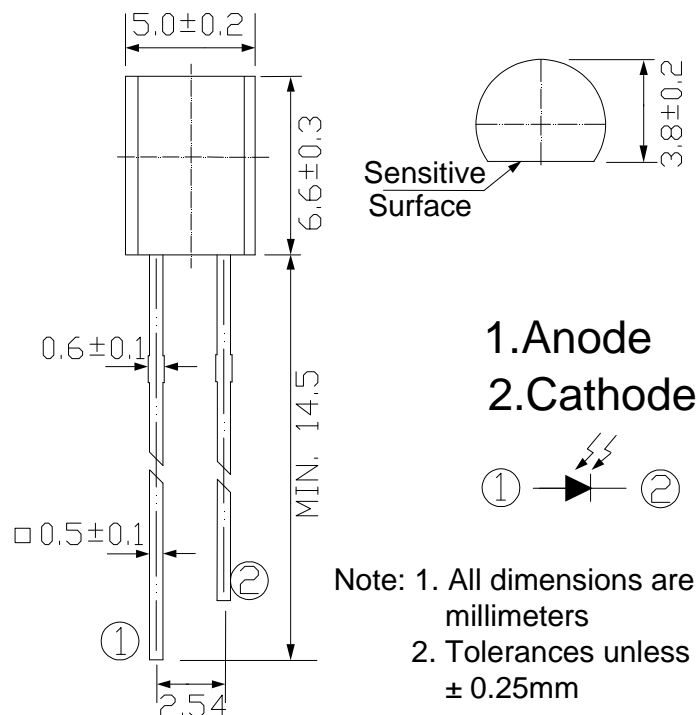

### ■ Absolute Maximum Ratings (Ta=25°C)

Parameter	Symbol	Rating	Units
Reverse Voltage	VR	32	V
Power Dissipation	Pd	150	mW
Lead Soldering Temperature	Tsol	260	°C
Operating Temperature	Topr	-40 ~ +85	°C
Storage Temperature	Tstg	-40 ~ +85	°C

### ■ Electro-Optical Characteristics (Ta=25°C)

Parameter	Symbol	Condition	Min.	Typ.	Max.	Units
Rang of Spectral Bandwidth	$\lambda_{0.5}$	----	400	----	1100	nm
Wavelength of Peak Sensitivity	$\lambda_p$	----	----	940	----	nm
Open-Circuit Voltage	Voc	Ee=5m W/cm <sup>2</sup> $\lambda_p=940\text{nm}$	----	0.35	----	V
Short- Circuit Current	Isc	Ee=5m W/cm <sup>2</sup> $\lambda_p=940\text{nm}$	----	80	----	$\mu\text{A}$
Reverse Light Current	IL	Ee=5m W/cm <sup>2</sup> $\lambda_p=940\text{nm}$ VR=5V	----	80	----	$\mu\text{A}$
Dark Current	Id	Ee=0m W/cm <sup>2</sup> VR=10V	----	----	30	nA
Reverse Breakdown	BVR	Ee=0m W/cm <sup>2</sup> IR=100 $\mu\text{A}$	35	----	----	V
Total Capacitance	Ct	Ee=0m W/cm <sup>2</sup> VR=3V f=1MHZ	----	44	----	pF
Rise/Fall Time	tr/ta	VR=10V RL=1K $\Omega$		60/60		nS

■ **Typical Electro-Optical Characteristics Curves**

Fig.1 Power Dissipation vs. Ambient Temperature

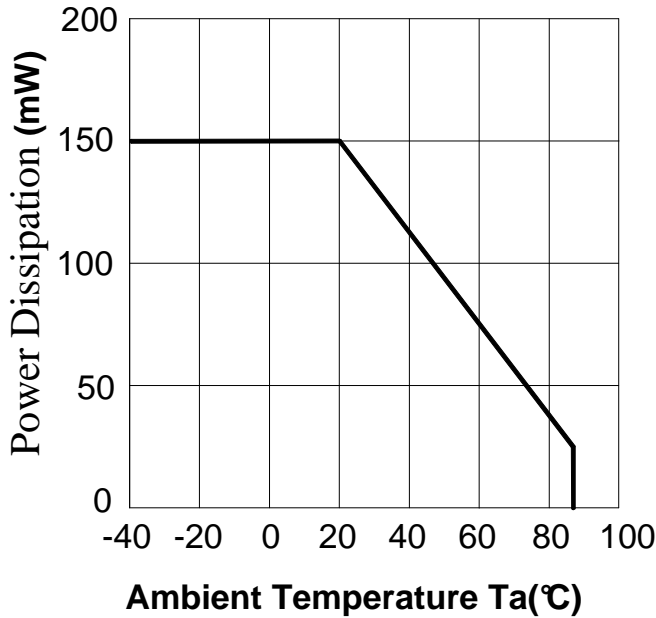

Fig.2 Spectral Sensitivity

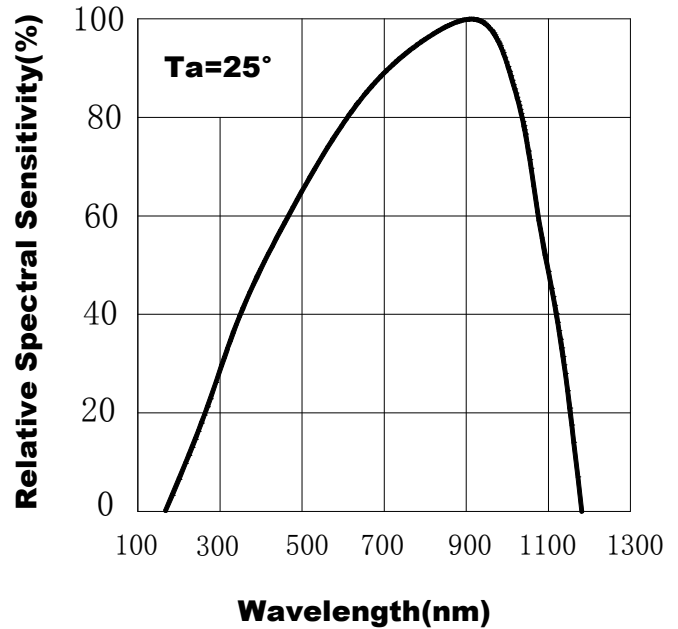

Fig.3 Dark Current vs. Ambient Temperature

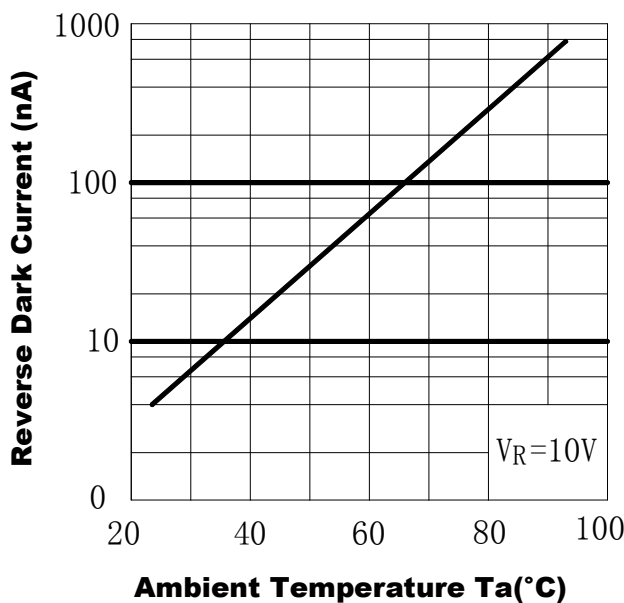

Fig.4 Reverse Light Current vs.  $E_e$

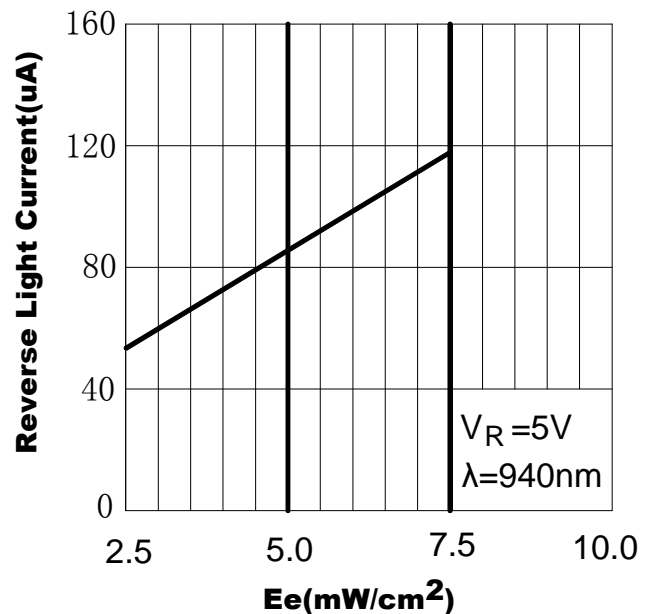

Fig.5 Terminal Capacitance vs.  
Reverse Voltage

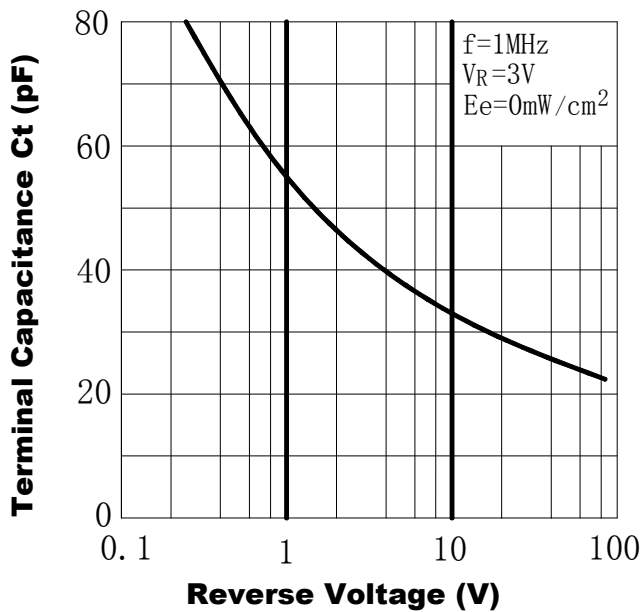
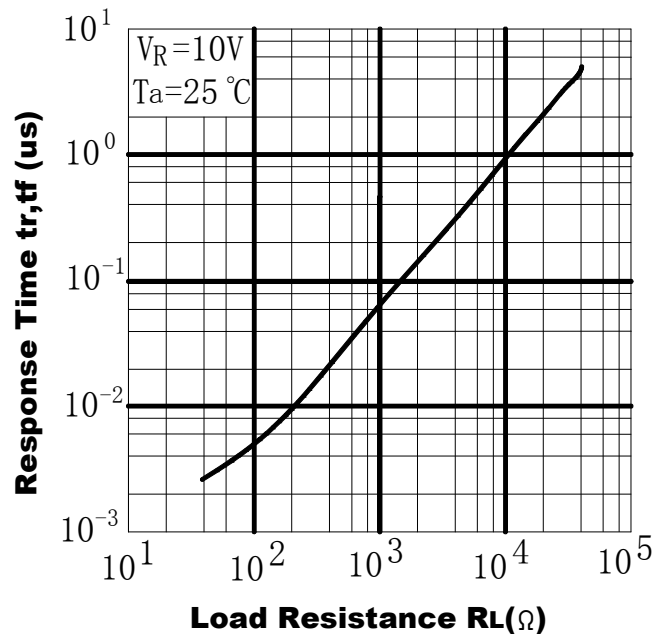

Fig.6 Response Time vs.  
Load Resistance



## ■ Packing Quantity Specification

1. 1000PCS/1Bag

## ■ Notes

1. Above specification may be changed without notice. SHUGUAN will reserve authority on material change for above specification.
2. When using this product, please observe the absolute maximum ratings and the instructions for using outlined in these specification sheets. SHUGUAN assumes no responsibility for any damage resulting from use of the product which does not comply with the absolute maximum ratings and the instructions included in these specification sheets.
3. These specification sheets include materials protected under copyright of SHUGUAN corporation. Please don't reproduce or cause anyone to reproduce them without SHUGUAN's consent.