

## Technical Data Sheet

### 10mm Infrared LED SIR0161



#### ■ Features

- High reliability
- High radiant intensity
- Peak wavelength  $\lambda_p=850\text{nm}$
- 2.54mm Lead spacing
- Low forward voltage
- Pb free
- The product itself will remain within RoHS compliant version.

#### ■ Descriptions

- SHUGUAN'S Infrared Emitting Diode(SIR0161) is a high intensity diode , molded in a water clear plastic package.
- The device is spectrally matched with phototransistor , photodiode and infrared receiver module.

#### ■ Applications

- Free air transmission system
- Wireless earphones
- CCD of light
- Infrared applied system

■ Package Dimensions

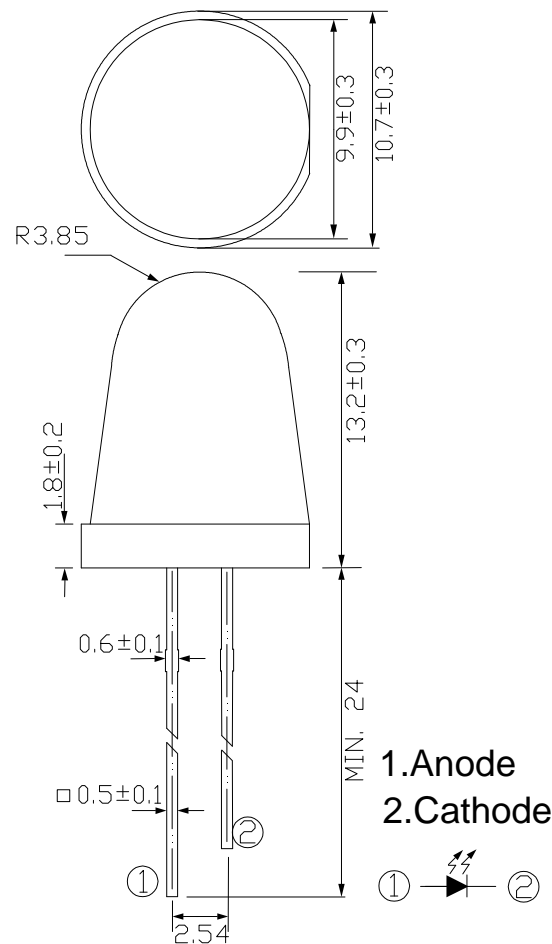

Note: 1. All dimensions are in millimeters  
 2. Tolerances unless dimensions  $\pm 0.25\text{mm}$

■ Absolute Maximum Ratings (Ta=25°C)

Parameter	Symbol	Rating	Units
Continuous Forward Current	I <sub>F</sub>	100	mA
Peak Forward Current *1	I <sub>FP</sub>	1.0	A
Reverse Voltage	V <sub>R</sub>	5	V
Lead Soldering Temperature *2	T <sub>sol</sub>	260	°C
Operating Temperature	T <sub>opr</sub>	-40 ~ +85	°C
Storage Temperature	T <sub>stg</sub>	-40 ~ +85	°C
Power Dissipation at(or below) 25°C Free Air Temperature	P <sub>d</sub>	150	mW

Notes: \*1: I<sub>FP</sub> Conditions--Pulse Width  $\leq 100 \mu\text{s}$  and Duty  $\leq 1\%$ .

\*2: Soldering time  $\leq 5$  seconds.

### ■ Electro-Optical Characteristics (Ta=25°C)

Parameter	Symbol	Condition	Min.	Typ.	Max.	Units
Radiant Intensity	Ee	I <sub>F</sub> =20mA	25	45	--	mW/sr
		I <sub>F</sub> =100mA Pulse Width ≤100 μs ,Duty≤1%	--	55	--	
		I <sub>F</sub> =1A Pulse Width ≤100 μs ,Duty≤1%.	--	400	--	
Peak Wavelength	λ <sub>p</sub>	I <sub>F</sub> =20mA	--	850	--	nm
Spectral Bandwidth	Δλ	I <sub>F</sub> =20mA	--	50	---	nm
Forward Voltage	V <sub>F</sub>	I <sub>F</sub> =20mA	--	1.4	1.5	V
		I <sub>F</sub> =100mA Pulse Width ≤100 μs ,Duty≤1%	--	1.8	2.0	
		I <sub>F</sub> =1A Pulse Width ≤100 μs ,Duty≤1%.	--	2.8	3.6	
Reverse Current	I <sub>R</sub>	V <sub>R</sub> =5V	--	--	10	μA
View Angle	2θ 1/2	I <sub>F</sub> =20mA	--	10	--	deg

### ■ Typical Electro-Optical Characteristics Curves

Fig.1 Forward Current vs.  
Ambient Temperature

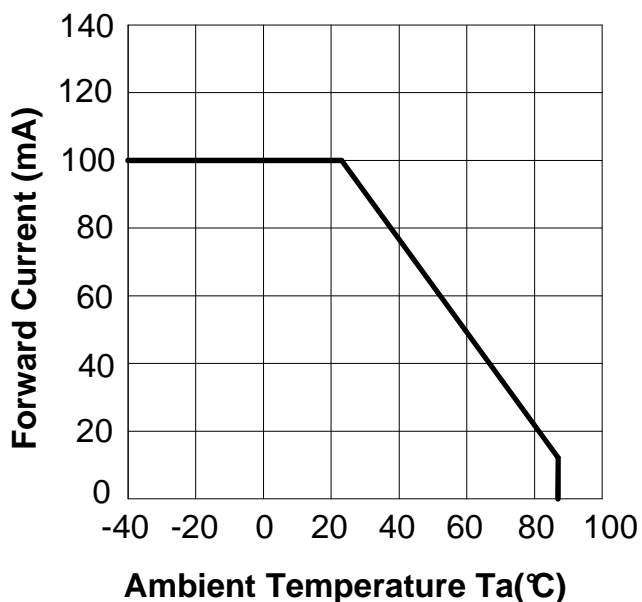

Fig.2 Spectral Distribution

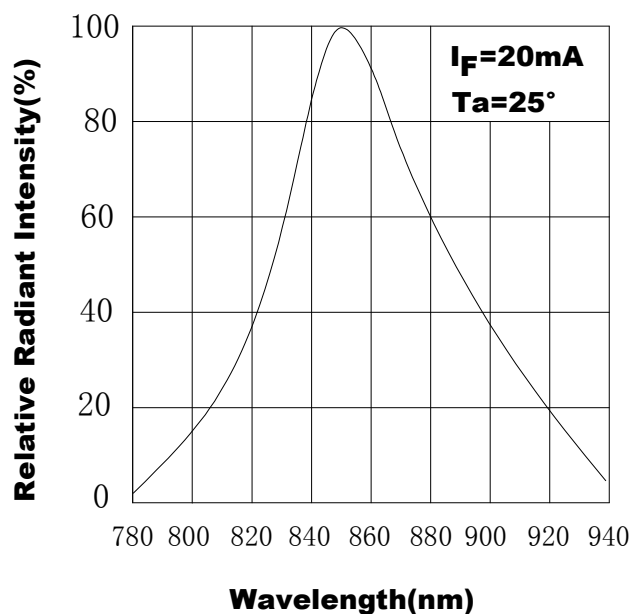

Fig.3 Peak Emission Wavelength vs. Ambient Temperature

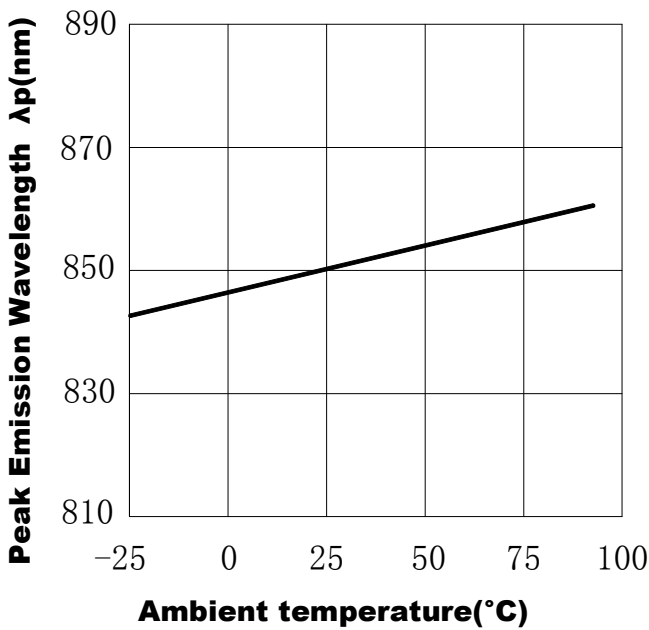

Fig.4 Forward Current vs. Forward Voltage

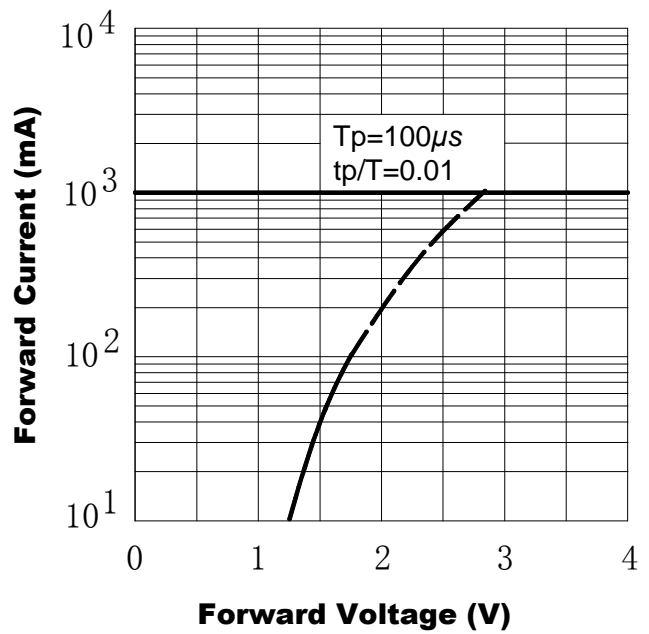

Fig.5 Radiant Intensity vs. Forward Current

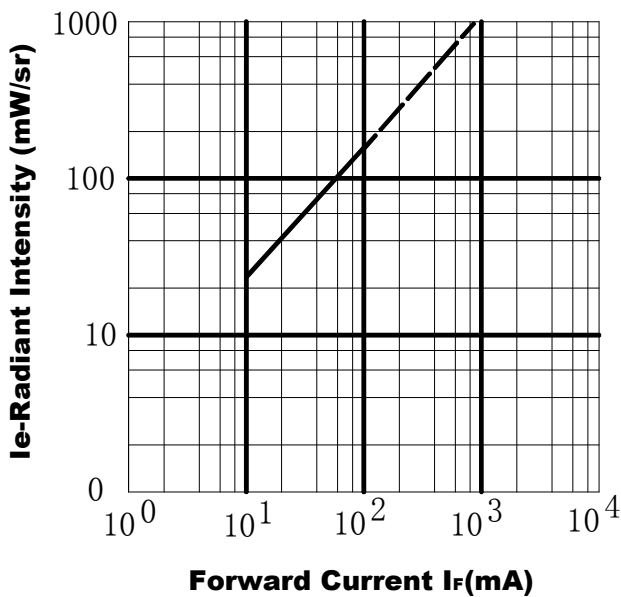

Fig.6 Relative Radiant Intensity vs. Angular Displacement

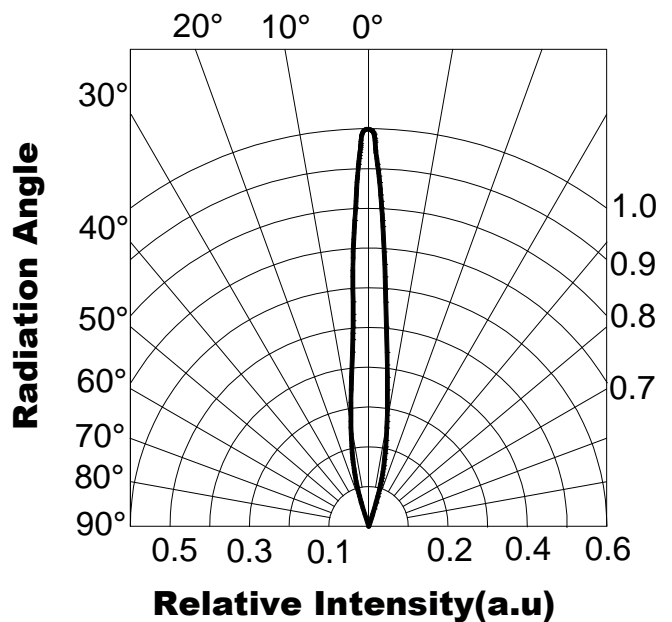

Fig.7 Relative Intensity vs.  
Ambient Temperature ( $^{\circ}\text{C}$ )

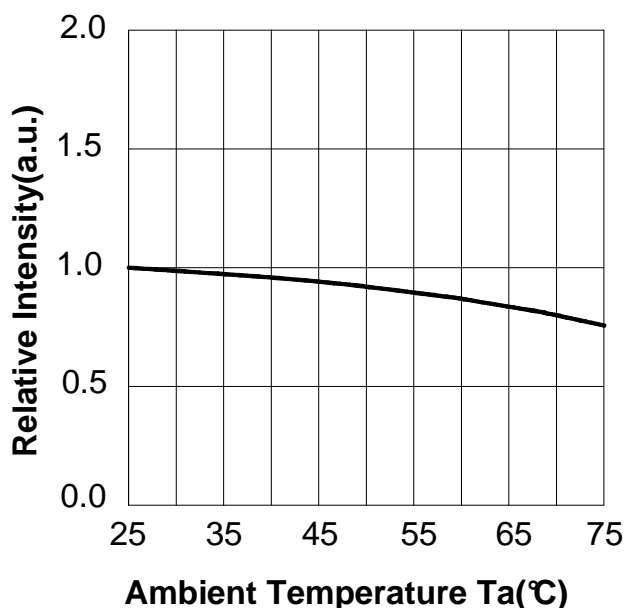
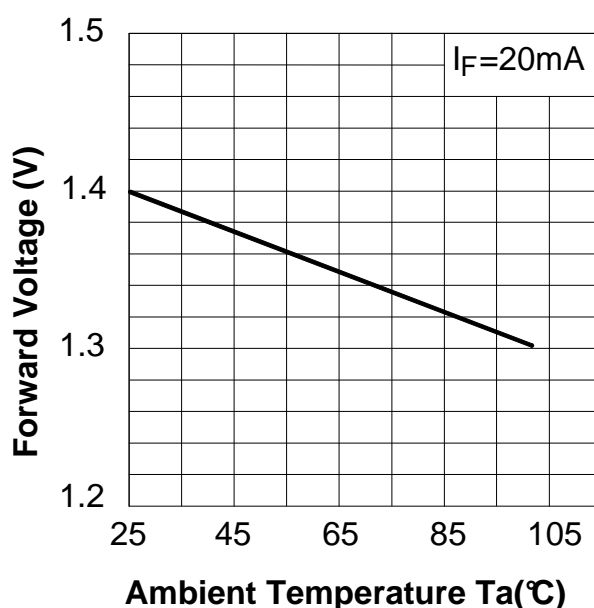

Fig.8 Forward Voltage vs.  
Ambient Temperature ( $^{\circ}\text{C}$ )



Notes:

1. Above specification may be changed without notice. SHUGUAN will reserve authority on material change for above specification
2. When using this product, please observe the absolute maximum ratings and the instructions for use outlined in these specification sheets. SHUGUAN assumes no responsibility for any damage resulting from use of the product which does not comply with the absolute maximum ratings and the instructions included in these specification