

## Technical Data Sheet

### 5mm Infrared LED SIR5061

#### ■ Features

- High reliability
- High radiant intensity
- Peak wavelength  $\lambda_p=940\text{nm}$
- 2.54mm Lead spacing
- Low forward voltage
- Pb free
- The product itself will remain within RoHS compliant version.

#### ■ Descriptions

- SHUGUAN'S Infrared Emitting Diode(SIR5061) is a high intensity diode , molded in a water clear plastic package.
- The device is spectrally matched with phototransistor , photodiode and infrared receiver module.

#### ■ Applications

- Free air transmission system
- Infrared remote control units with high power requirement
- Smoke detector
- Infrared applied system



■ **Package Dimensions**

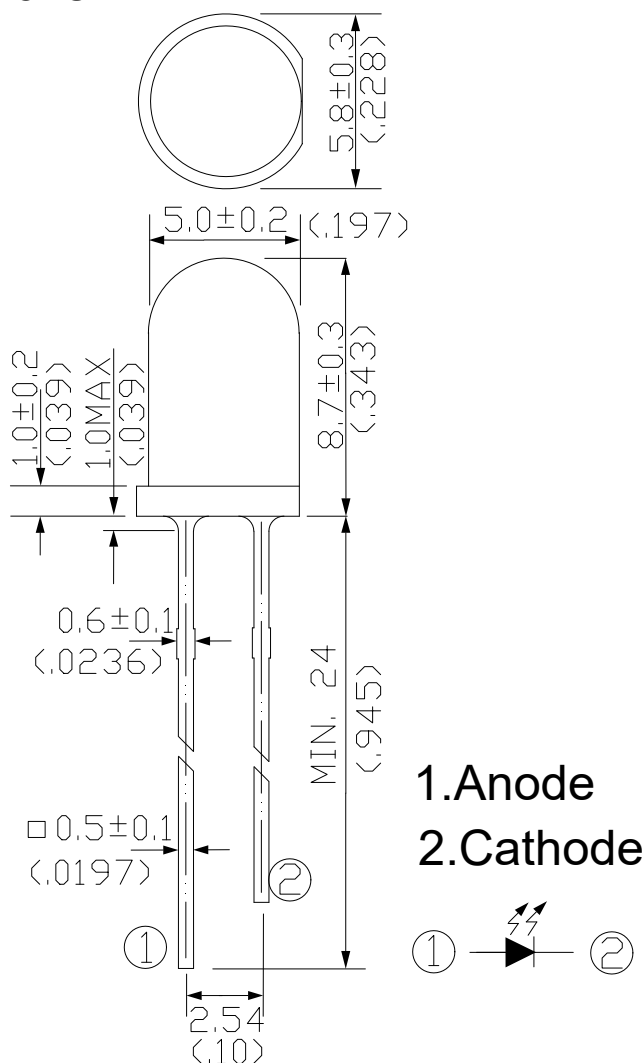

Note: 1. All dimensions are in millimeters(inches)  
 2. Tolerances unless dimensions  $\pm 0.25\text{mm}(.01\text{'})$

■ **Absolute Maximum Ratings (Ta=25°C)**

Parameter	Symbol	Rating	Units
Continuous Forward Current	I <sub>F</sub>	50	mA
Peak Forward Current	I <sub>FP</sub>	0.5	A
Reverse Voltage	V <sub>R</sub>	5	V
Lead Soldering Temperature	T <sub>sol</sub>	260	°C
Operating Temperature	T <sub>opr</sub>	-20 ~ +85	°C
Storage Temperature	T <sub>stg</sub>	-40 ~ +85	°C
Power Dissipation at(or below) 25°C Free Air Temperature	P <sub>d</sub>	100	mW

Notes: \*1: I<sub>FP</sub> Conditions--Pulse Width  $\leq 100 \mu\text{s}$  and Duty  $\leq 1\%$ .

\*2: Soldering time  $\leq 5$  seconds.

■ **Electro-Optical Characteristics (Ta=25°C)**

Parameter	Symbol	Condition	Min.	Typ.	Max.	Units
Radiant Intensity	Ee	If=20mA	12.0	15.0	--	mW/sr
		If=50mA Pulse Width $\leq$ 100 $\mu$ s ,Duty $\leq$ 1%	--	25	--	
		If=500mA Pulse Width $\leq$ 100 $\mu$ s ,Duty $\leq$ 1%.	--	160	--	
Peak Wavelength	$\lambda_p$	If=20mA	--	940	--	nm
Spectral Bandwidth	$\Delta \lambda$	If=20mA	--	50	---	nm
Forward Voltage	VF	If=20mA	--	1.2	1.5	V
		If=50mA Pulse Width $\leq$ 100 $\mu$ s ,Duty $\leq$ 1%	--	1.3	1.6	
		If=500mA Pulse Width $\leq$ 100 $\mu$ s ,Duty $\leq$ 1%.	--	2.3	2.8	
Reverse Current	IR	VR=5V	--	--	10	$\mu$ A
View Angle	2 $\theta$ 1/2	If=20mA	--	15	--	deg

■ **Typical Electro-Optical Characteristics Curves**

Fig.1 Forward Current vs.

Ambient Temperature

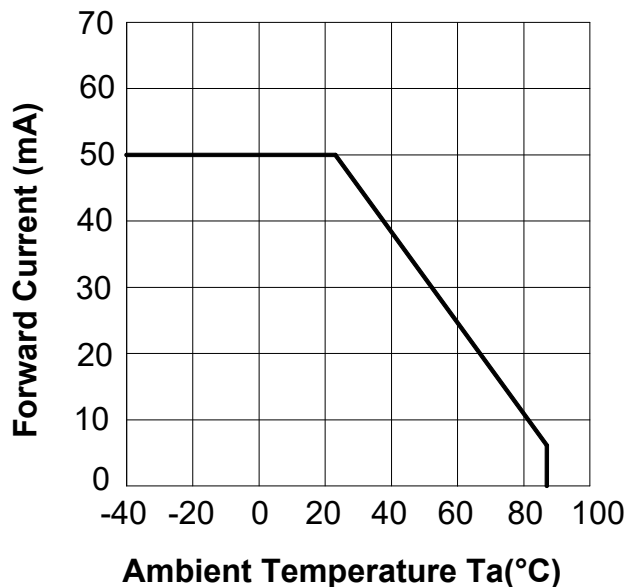

Fig.2 Spectral Distribution

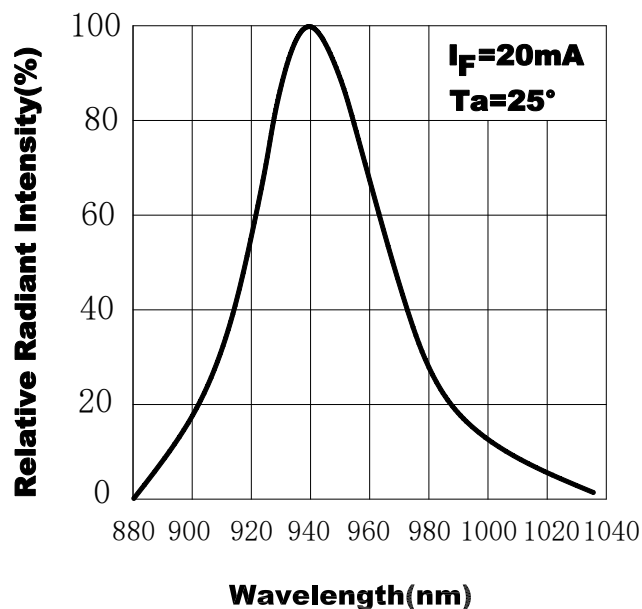

Fig.3 Peak Emission Wavelength vs. Ambient Temperature

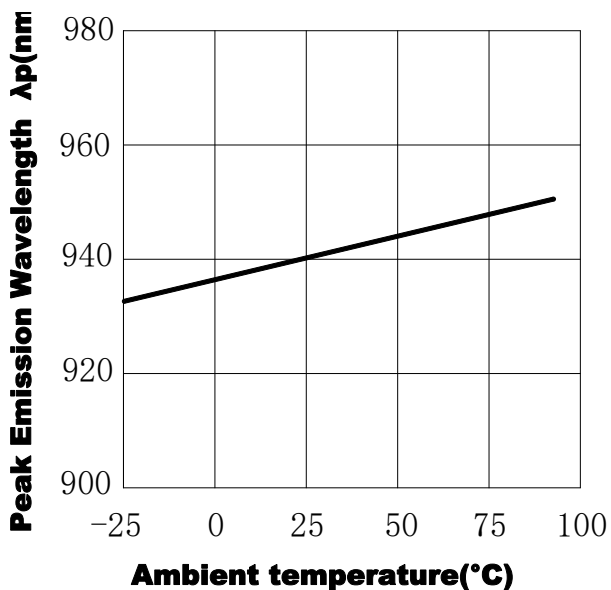

Fig.4 Forward Current vs. Forward Voltage

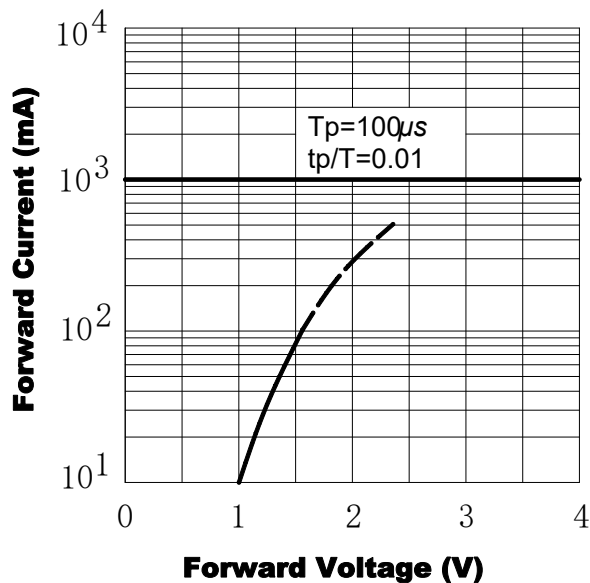

Fig.5 Radiant Intensity vs. Forward Current

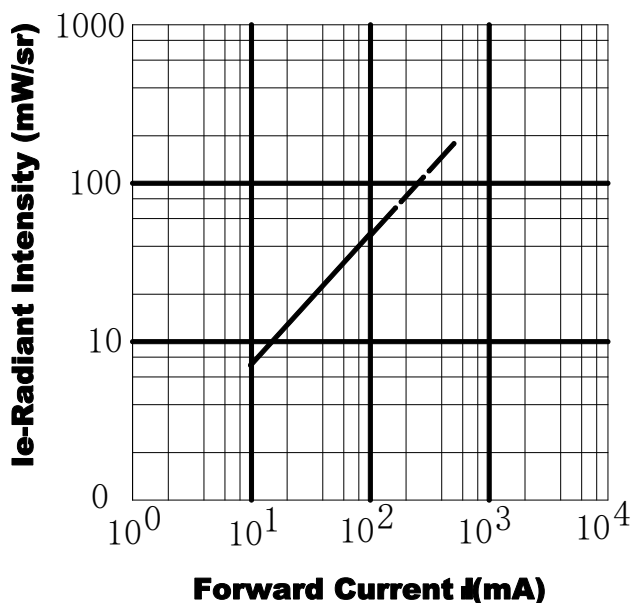

Fig.6 Relative Radiant Intensity vs. Angular Displacement

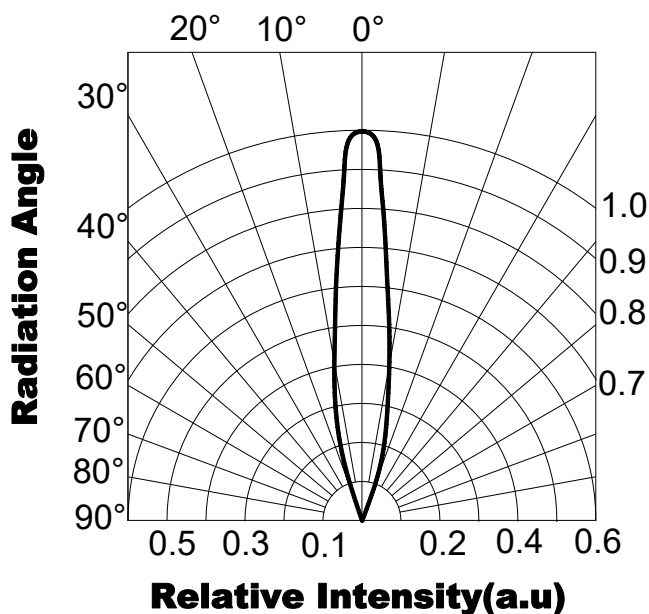

Fig.7 Relative Intensity vs. Ambient Temperature (°C)

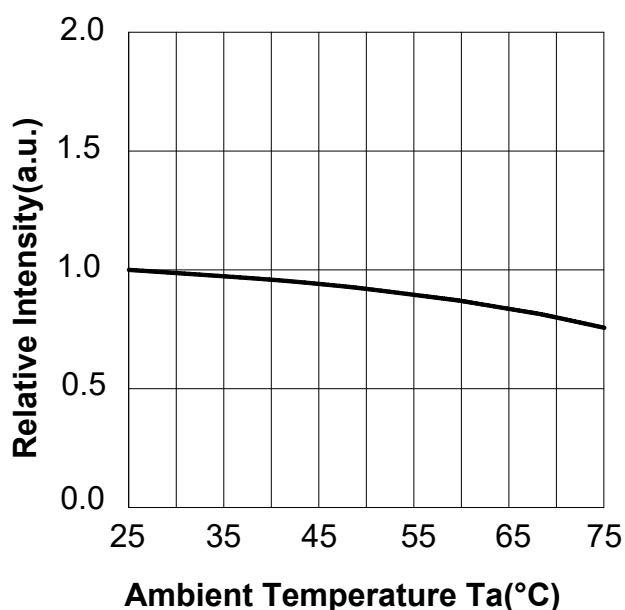
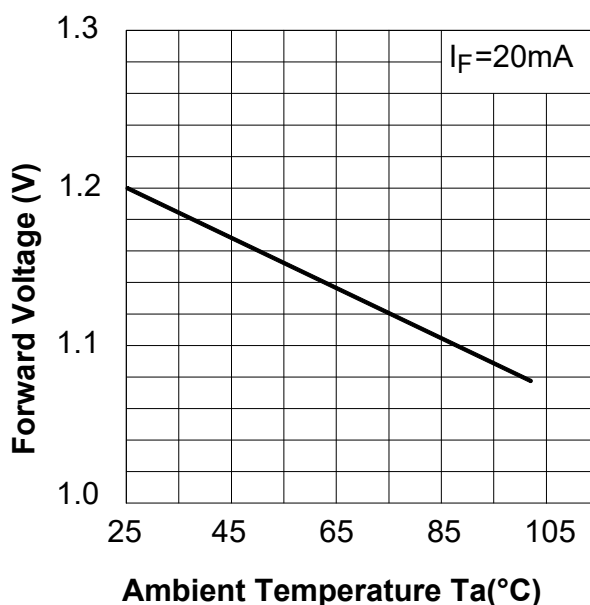

Fig.8 Forward Voltage vs. Ambient Temperature (°C)



■ **Packing Quantity Specification**

1. 1000 PCS/1 Bag

■ **Notes**

1. Above specification may be changed without notice. SHUGUAN will reserve authority on material change for above specification.
2. Before using this product, be sure to test it. The use and storage conditions must not exceed the limit parameters specified in this manual. The company will not be responsible for any damage to the product caused by the use of the product beyond the limit parameters.
3. Stored at a temperature not higher than 30° C and humidity not higher than 60%RH, the product shelf life is 6 months. Keeping the product in an airtight container with a desiccant can extend the shelf life of the product to some extent. Poor storage conditions can cause corrosion of product leads or changes in product performance.
4. After opening, the product must be used within 168 hours (recommended working environment temperature not higher than 30 °C, humidity not higher than 60%). If it is not used up, the remaining material must be stored in an environment where the temperature is not higher than 30° C and the humidity is not higher than 10%.
5. For products that have not been soldered, if the hygroscopic agent or packaging fails, or the product does not meet the above valid storage conditions, baking can play a certain performance recovery effect. Baking conditions: 65 ± 5°C, duration 96H.
6. Static electricity and surges will cause changes in product characteristics, such as forward voltage reduction, etc. If the situation is serious, it will even damage the product, so effective anti-static measures must be taken during use. All related equipment and machines should be

properly grounded, and other measures against static electricity and surges must be taken. The use of anti-static wristbands, anti-static mats, anti-static work clothes, work shoes, gloves, and anti-static containers are all effective measures to prevent static electricity and surges.

7. When designing the circuit, the current passing through the product cannot exceed the specified maximum value, and a current limiting resistor must be used at the same time, otherwise a small voltage change will cause a large current change, which may lead to product damage.
8. Shaping of the pins must be done before soldering. When shaping, the bending position of the lead must be at least 3mm from the bottom of the encapsulation resin, while avoiding bending the same position multiple times.
9. Use a suitable tool to hold the pins in place while shaping to avoid stressing the resin. In particular, the connection part between the pin and the resin cannot be used as a fulcrum. The stress generated in this way will directly damage the light-emitting structure inside the product, resulting in changes in product characteristics or even damage.
10. When assembling the product, the distance between the solder holes on the PCB must be strictly matched with the pin spacing of the product.
11. Welding should pay special attention to:
  - (1) Manual soldering: the tip temperature of the soldering iron (up to 30W) should not exceed 350° C; the soldering iron must be grounded, and the static electricity should not exceed the range; the soldering time should not exceed 3 seconds; the soldering position should be at least 3 mm away from the colloid.
  - (2) Dip soldering: the maximum temperature for dip soldering is 260° C; the dip soldering time does not exceed 5 seconds; the dip soldering position is at least 3 mm away from the colloid.